

CATALOGO
CATALOGUE



CODICE ARTICOLO - ARTICLE CODE

101

DESCRIZIONE - DESCRIPTION

Appendiabito verniciato o cromato con dettagli in plastica

Varnished or chromed coat stand with plastic fittings

COLORI - COLOURS

argento - silver
bianco - white
nero - black
rosso - red

DETTAGLI TECNICI - TECHNICAL DATA

pezzi per scatola - pcs per box: **01**
peso lordo - gross weight: **4.93 Kg**

IMBALLO - PACKING

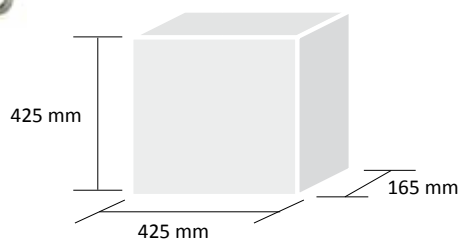

cromato - chromed



CODICE ARTICOLO - ARTICLE CODE

101 MIX

DESCRIZIONE - DESCRIPTION

Appendiabito verniciato argento con plastiche colorate

Silver varnished coat stand with colored plastic fittings

COLORI - COLOURS

arancione - orange
blu - blue
giallo - yellow
nero - black
rosso - red
verde - green

DETTAGLI TECNICI - TECHNICAL DATA

pezzi per scatola - pcs per box: **01**
peso lordo - gross weight: **6.62 Kg**

IMBALLO - PACKING

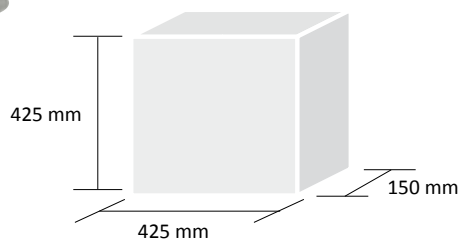



CODICE ARTICOLO - ARTICLE CODE

130

DESCRIZIONE - DESCRIPTION

Appendiabito in metallo in tre versioni: verniciato nero, cromato con piastra nera oppure tutto cromato

Metal coat stand in 3 models: black varnished, chromed with black basement or all chromed

COLORI - COLOURS

nero - black

DETTAGLI TECNICI - TECHNICAL DATA

pezzi per scatola - pcs per box: **01**
peso lordo - gross weight: **6.75 Kg**

IMBALLO - PACKING

cromato con piastra verniciata nera
chromed with black varnished basement

tutto cromato - all chromed

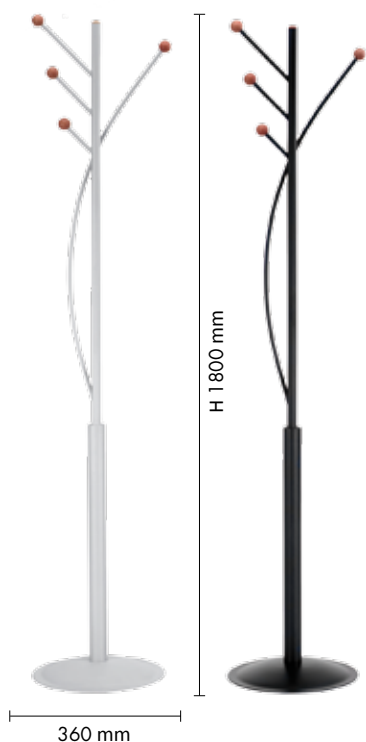
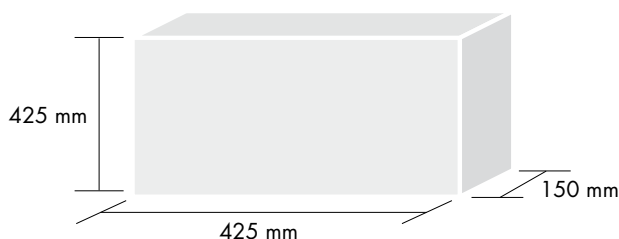

CODICE ARTICOLO - ARTICLE CODE

235 LUNA

DESCRIZIONE - DESCRIPTION

Appendiabito in metallo con dettagli in legno

Metal coat stand with wooden fittings

COLORI - COLOURS

argento - silver
nero - black

DETTAGLI TECNICI - TECHNICAL DATA

pezzi per scatola - pcs per box: **01**
peso lordo - gross weight: **5.83 Kg**

IMBALLO - PACKING

argento - silver
nero - black

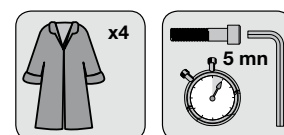
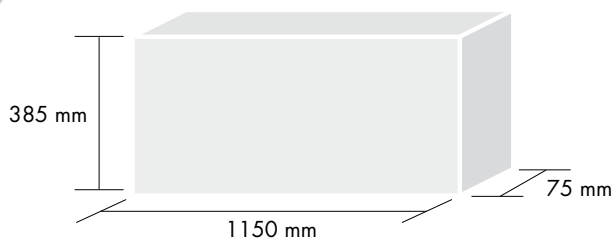



CODICE ARTICOLO - ARTICLE CODE

235 LUNA CON PORTAOMBRELLI

DESCRIZIONE - DESCRIPTION

Appendiabito in metallo con dettagli in legno e portaombrelli

Metal coat stand with wooden fittings and umbrella holder

COLORI - COLOURS

argento - silver
nero - black

DETTAGLI TECNICI - TECHNICAL DATA

pezzi per scatola - pcs per box: **01**
peso lordo - gross weight: **6.04 Kg**

IMBALLO - PACKING

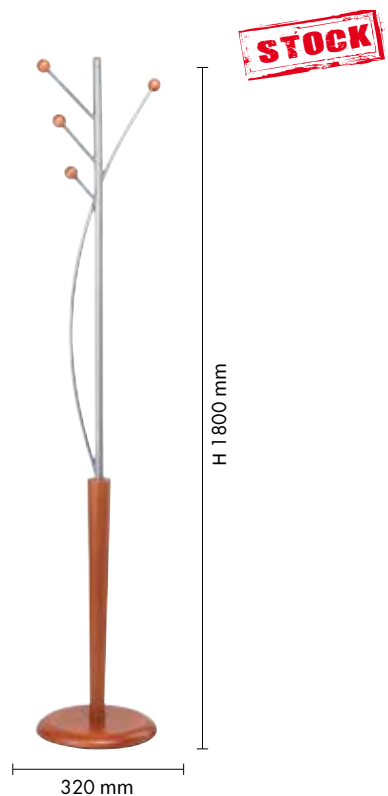
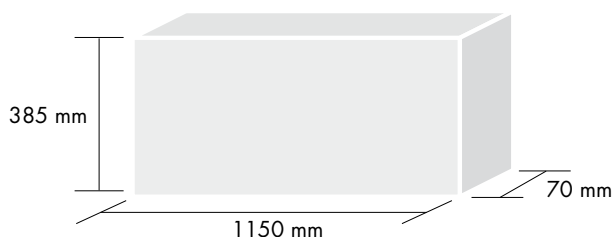

CODICE ARTICOLO - ARTICLE CODE

235 LUNA LUSO

DESCRIZIONE - DESCRIPTION

Appendiabito con parte inferiore, base e accessori in legno, testa in metallo verniciato argento

Coat stand with lower part, basement and fittings made of wood, silver varnished metal head

COLORI - COLOURS

ciliegio/argento
cherry wood/silver
wengè/argento
wengè/silver

DETTAGLI TECNICI - TECHNICAL DATA

pezzi per scatola - pcs per box: **01**
peso lordo - gross weight: **7.48 Kg**

IMBALLO - PACKING

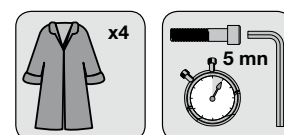
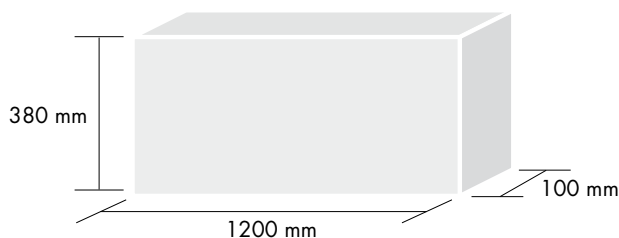



CODICE ARTICOLO - ARTICLE CODE

260 BISTROT

DESCRIZIONE - DESCRIPTION

Appendiabito in metallo verniciato

Metal varnished coat stand

COLORI - COLOURS

bianco - white

nero - black

DETTAGLI TECNICI - TECHNICAL DATA

pezzi per scatola - pcs per box: **01**

peso lordo - gross weight: **6.11 Kg**

IMBALLO - PACKING

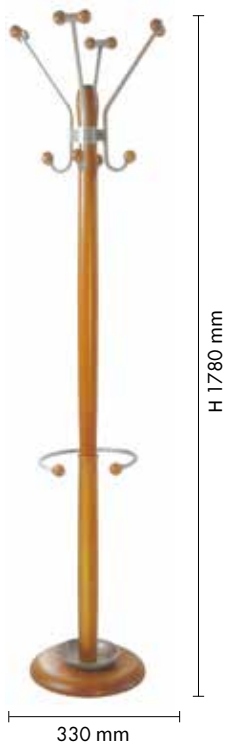
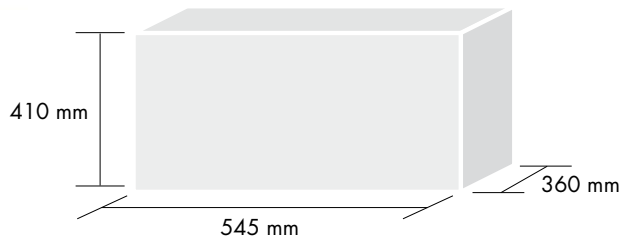

CODICE ARTICOLO - ARTICLE CODE

500 ELITE LUSSO

DESCRIZIONE - DESCRIPTION

Appendiabito con telaio e accessori in legno, componenti in metallo

Wooden fittings and wooden frame coat stand, metal parts

COLORI - COLOURS

ciliegio (accessori argento)
cherry wood (silver fittings)

wengé (accessori argento)
wengé (silver fittings)

DETTAGLI TECNICI - TECHNICAL DATA

pezzi per scatola - pcs per box: **01**

peso lordo - gross weight: **9.30 Kg**

IMBALLO - PACKING

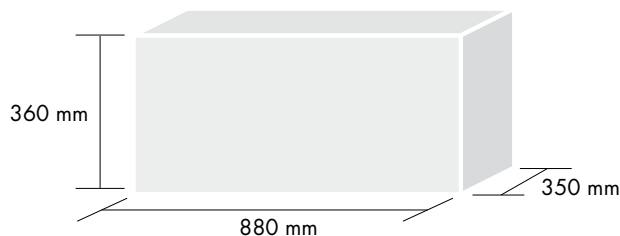



CODICE ARTICOLO - ARTICLE CODE

530 DALLAS

DESCRIZIONE - DESCRIPTION

Appendiabito in metallo verniciato con inserti in legno e portaombrelli

Metal varnished coat stand with wooden fittings and umbrella holder

COLORI - COLOURS

argento - silver
nero - black

DETTAGLI TECNICI - TECHNICAL DATA

pezzi per scatola - pcs per box: **01**
peso lordo - gross weight: **6.21 Kg**

IMBALLO - PACKING

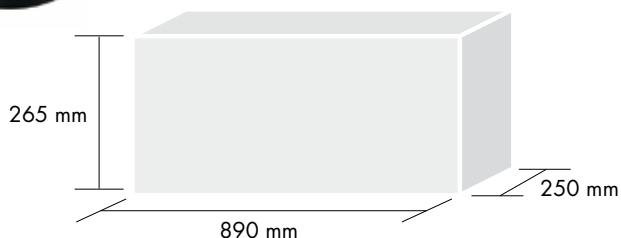

CODICE ARTICOLO - ARTICLE CODE

540 ORIONE

DESCRIZIONE - DESCRIPTION

Appendiabito in metallo verniciato con inserti in legno e portaombrelli

Metal varnished coat stand with wooden fittings and umbrella holder

COLORI - COLOURS

argento - silver
nero - black

DETTAGLI TECNICI - TECHNICAL DATA

pezzi per scatola - pcs per box: **01**
peso lordo - gross weight: **6.06 Kg**

IMBALLO - PACKING

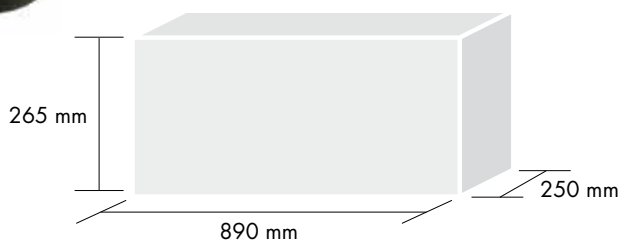

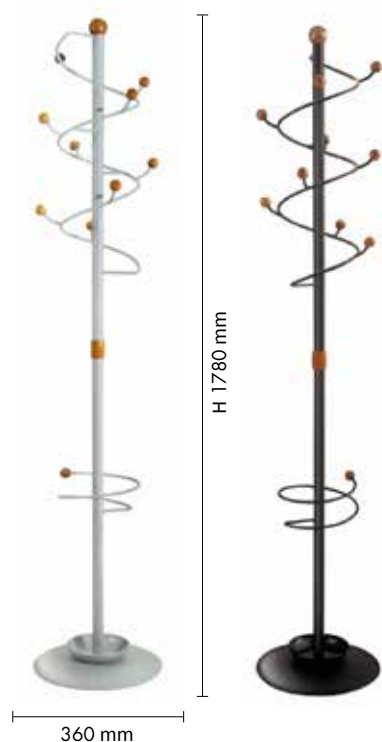

CODICE ARTICOLO - ARTICLE CODE

604 VORTICE

DESCRIZIONE - DESCRIPTION

Appendiabito in metallo verniciato con inserti in legno e portaombrelli

Metal varnished coat stand with wooden fittings and umbrella holder

COLORI - COLOURS

argento - silver
nero - black

DETTAGLI TECNICI - TECHNICAL DATA

pezzi per scatola - pcs per box: **01**
peso lordo - gross weight: **7.71 Kg**

IMBALLO - PACKING

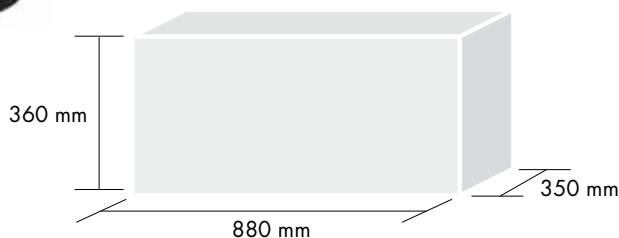

CODICE ARTICOLO - ARTICLE CODE

620 VULCANO

DESCRIZIONE - DESCRIPTION

Appendiabito in metallo verniciato con inserti in legno e portaombrelli

Metal varnished coat stand with wooden fittings and umbrella holder

COLORI - COLOURS

argento - silver
nero - black

DETTAGLI TECNICI - TECHNICAL DATA

pezzi per scatola - pcs per box: **01**
peso lordo - gross weight: **9.12 Kg**

IMBALLO - PACKING

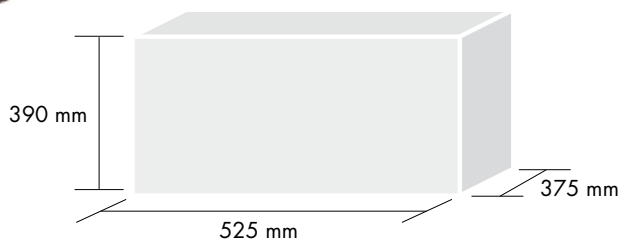



CODICE ARTICOLO - ARTICLE CODE

640 ORO

DESCRIZIONE - DESCRIPTION

Appendiabito in metallo verniciato con inserti in legno e portaombrelli

Metal varnished coat stand with wooden fittings and umbrella holder

COLORI - COLOURS

argento - silver
nero - black

DETTAGLI TECNICI - TECHNICAL DATA

pezzi per scatola - pcs per box: **01**
peso lordo - gross weight: **6.25 Kg**

IMBALLO - PACKING

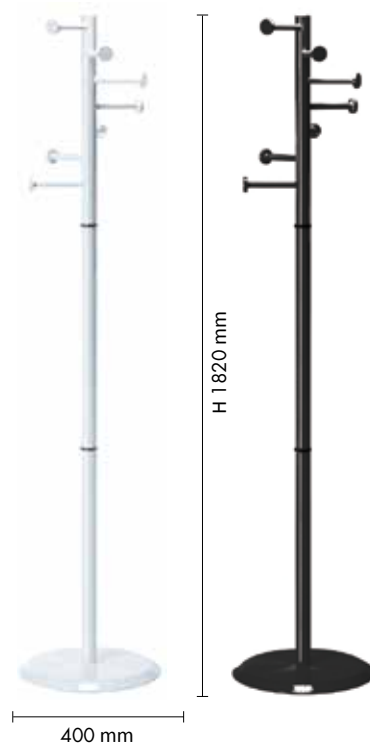
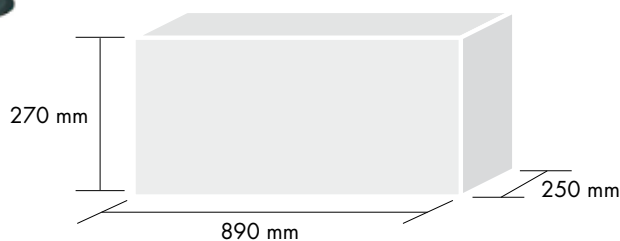

CODICE ARTICOLO - ARTICLE CODE

802 PRIMULA

DESCRIZIONE - DESCRIPTION

Appendiabito in metallo verniciato

Metal varnished coat stand

COLORI - COLOURS

bianco - white
nero - black

DETTAGLI TECNICI - TECHNICAL DATA

pezzi per scatola - pcs per box: **01**
peso lordo - gross weight: **8.50 Kg**

IMBALLO - PACKING

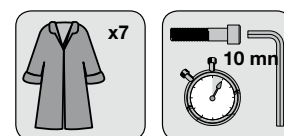
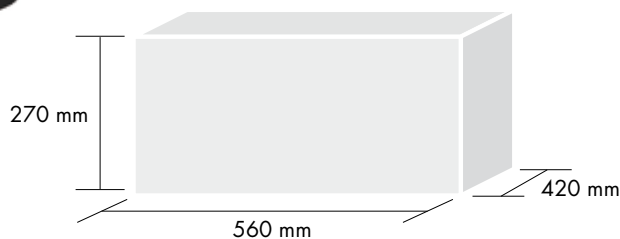

CODICE ARTICOLO - ARTICLE CODE

810 BRANCH

DESCRIZIONE - DESCRIPTION

Appendiabito in metallo verniciato

Metal varnished coat stand

COLORI - COLOURS

argento (pomoli neri)
silver (black hooks)

bianco (pomoli neri)
white (black hooks)

nero (pomoli argento)
black (silver hooks)

DETTAGLI TECNICI - TECHNICAL DATA

pezzi per scatola - pcs per box: **01**
peso lordo - gross weight: **8.40 Kg**

IMBALLO - PACKING

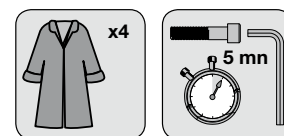
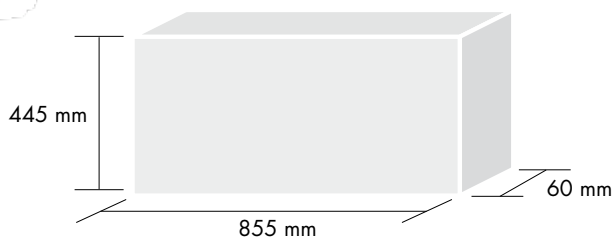
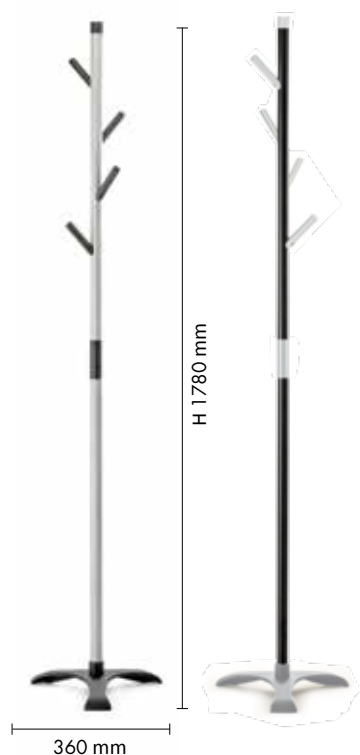

CODICE ARTICOLO - ARTICLE CODE

820 GISELLE

DESCRIZIONE - DESCRIPTION

Appendiabito verniciato con accessori in legno e vaschetta raccogli gocce in plastica

Varnished coat stand with wooden fittings and plastic drop tray

COLORI - COLOURS

argento (accessori ciliegio)
silver (cherry wooden fittings)

bianco (accessori ciliegio)
white (cherry wooden fittings)

nero (accessori faggio)
black (beech wooden fittings)

DETTAGLI TECNICI - TECHNICAL DATA

pezzi per scatola - pcs per box: **01**
peso lordo - gross weight: **8.35 Kg**

IMBALLO - PACKING

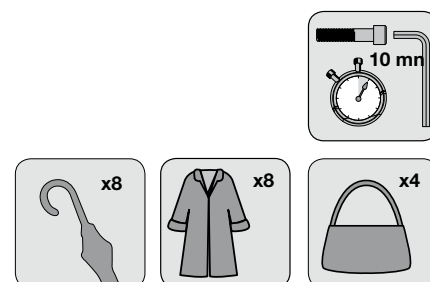
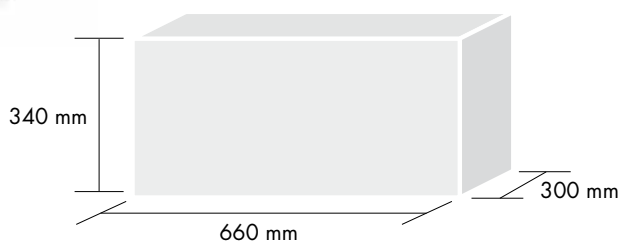



CODICE ARTICOLO - ARTICLE CODE

830 SOLEIL

DESCRIZIONE - DESCRIPTION

Appendiabito verniciato con accessori in faggio o ciliegio e testa girevole

Varnished coat stand with beech or cherry wooden fittings and revolving head

COLORI - COLOURS

argento - silver

bianco - white

nero - black

DETTAGLI TECNICI - TECHNICAL DATA

pezzi per scatola - pcs per box: **01**

peso lordo - gross weight: **8.12 Kg**

IMBALLO - PACKING

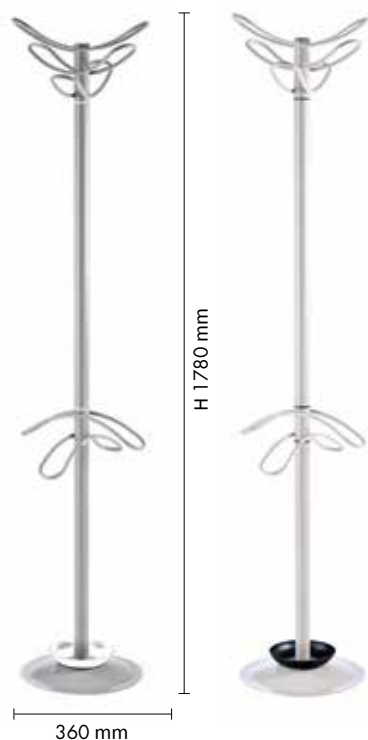
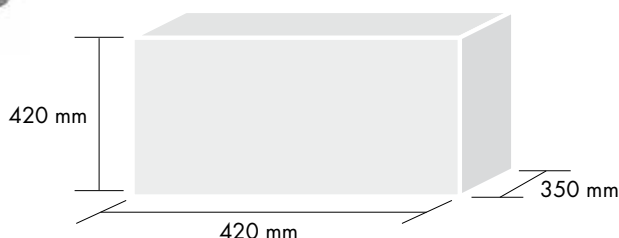

CODICE ARTICOLO - ARTICLE CODE

860 GILDA COLOR

DESCRIZIONE - DESCRIPTION

Appendiabito in metallo verniciato con portaombrelli in metallo e vaschetta raccogliogocce in plastica

Metal varnished coat stand with metal umbrella holder and plastic drop tray

COLORI - COLOURS

grigio - grey

tortora - beige

bianco - white

DETTAGLI TECNICI - TECHNICAL DATA

pezzi per scatola - pcs per box: **01**

peso lordo - gross weight: **7 Kg**

IMBALLO - PACKING

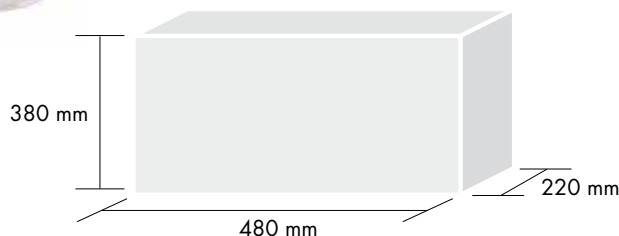



CODICE ARTICOLO - ARTICLE CODE

895 FLORA

DESCRIZIONE - DESCRIPTION

Appendiabiti in metallo verniciato
Metal varnished coat stand

COLORI - COLOURS

bianco/acc. neri
white/black fittings

argento/acc. neri
silver/black fittings

nero/acc. neri
black/black fittings

DETTAGLI TECNICI - TECHNICAL DATA

pezzi per scatola - pcs per box: **01**
peso lordo - gross weight: **8.58 Kg**

IMBALLO - PACKING

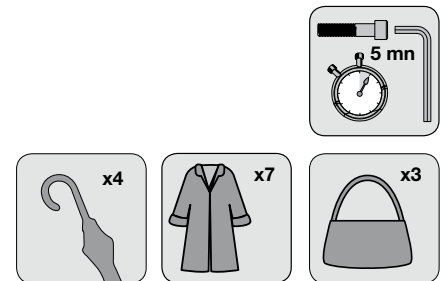
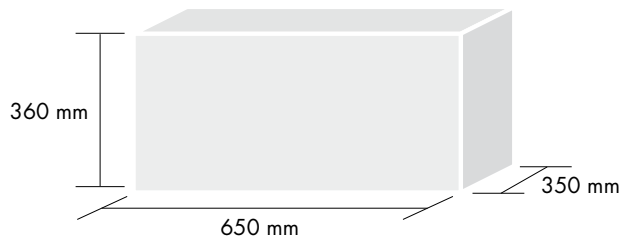

CODICE ARTICOLO - ARTICLE CODE

896 LILLY

DESCRIZIONE - DESCRIPTION

Appendiabiti in metallo verniciato con
accessori in legno

Metal varnished coat stand with
wooden fittings

COLORI - COLOURS

bianco/acc. legno
white/wooden fittings

argento/acc. legno
silver/wooden fittings

nero/acc. legno
black/wooden fittings

DETTAGLI TECNICI - TECHNICAL DATA

pezzi per scatola - pcs per box: **01**
peso lordo - gross weight: **7.42 Kg**

IMBALLO - PACKING

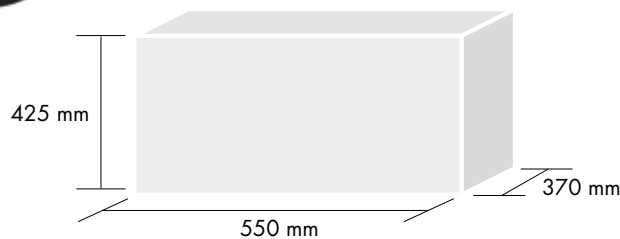



CODICE ARTICOLO - ARTICLE CODE

LUNA BIS con portaombrelli with umbrella holder

DESCRIZIONE - DESCRIPTION

Appendiabito verniciato con portaombrelli e accessori in legno

Varnished coat stand with umbrella holder and wooden fittings

COLORI - COLOURS

argento - silver
nero - black

DETTAGLI TECNICI - TECHNICAL DATA

pezzi per scatola - pcs per box: **01**
peso lordo - gross weight: **7.13 Kg**

IMBALLO - PACKING

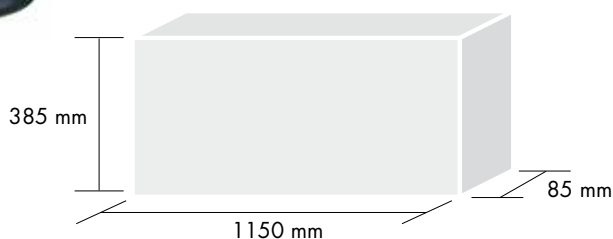

CODICE ARTICOLO - ARTICLE CODE

PETALO

DESCRIZIONE - DESCRIPTION

Appendiabito verniciato con accessori in legno

Metal varnished coat stand with wooden fittings

COLORI - COLOURS

bianco / legno
white / wooden fittings
argento / legno
silver / wooden fittings
nero / legno
black / wooden fittings

DETTAGLI TECNICI - TECHNICAL DATA

pezzi per scatola - pcs per box: **01**
peso lordo - gross weight: **8.06 Kg**

IMBALLO - PACKING

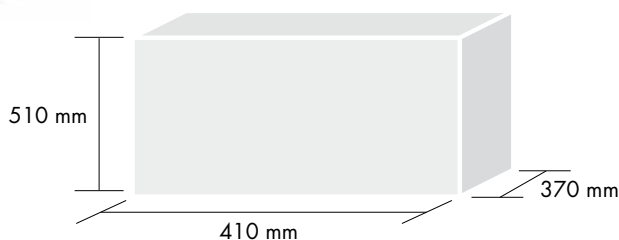

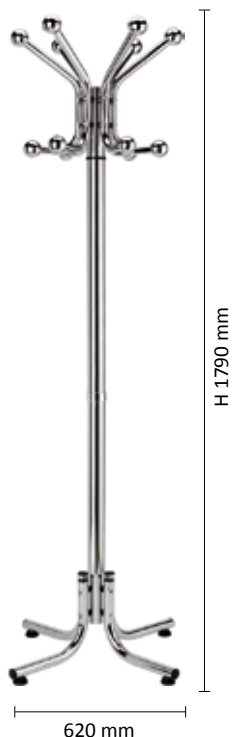

CODICE ARTICOLO - ARTICLE CODE

P121

DESCRIZIONE - DESCRIPTION

Appendiabito cromato

Chromed coat stand

COLORI - COLOURS

cromato - chromed

DETTAGLI TECNICI - TECHNICAL DATA

pezzi per scatola - pcs per box: **01**

peso lordo - gross weight: **6.55 Kg**

IMBALLO - PACKING

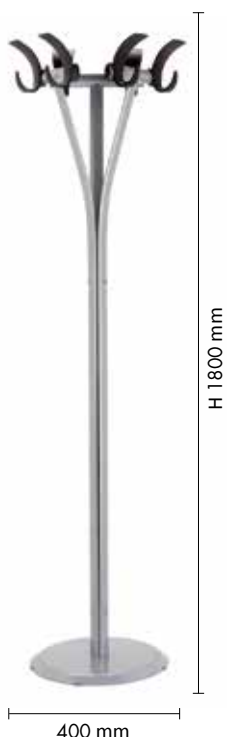
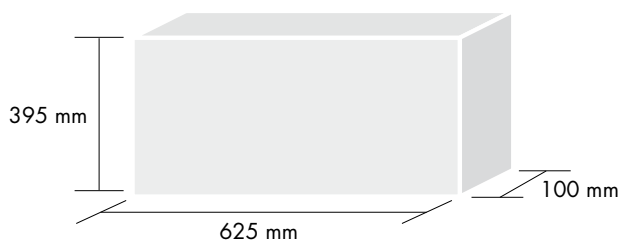

CODICE ARTICOLO - ARTICLE CODE

RICCIO A STELO

DESCRIZIONE - DESCRIPTION

Appendiabito con accessori in plastica

Coat stand with plastic fittings

COLORI - COLOURS

grigio accessori blu
grey with blue fittings

grigio accessori arancioni
grey with orange fittings

grigio accessori neri
grey with black fittings

DETTAGLI TECNICI - TECHNICAL DATA

pezzi per scatola - pcs per box: **01**

peso lordo - gross weight: **10 Kg**

IMBALLO - PACKING

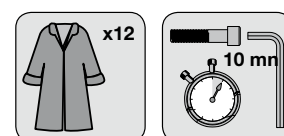
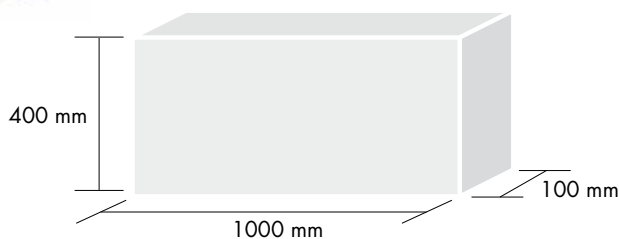



CODICE ARTICOLO - ARTICLE CODE

TULIPANO

DESCRIZIONE - DESCRIPTION

Appendiabito con base in metallo e accessori in plastica. Portaombrelli rotondo.

Coat stand with metal basement and plastic fittings. Ring umbrella holder.

COLORI - COLOURS

cromato/ accessori neri
chromed/black fittings

nero/ accessori neri
black/black fittings

bianco/ accessori neri
white/black fittings

DETTAGLI TECNICI - TECHNICAL DATA

pezzi per scatola - pcs per box: **01**

peso lordo - gross weight: **6 Kg**

IMBALLO - PACKING

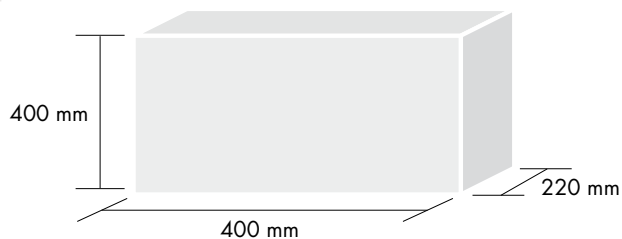



CODICE ARTICOLO - ARTICLE CODE

L3335

DESCRIZIONE - DESCRIPTION

Cestino in rete metallica traforata

Metal mesh waste bin

COLORI - COLOURS

argento - silver

nero - black

DETTAGLI TECNICI - TECHNICAL DATA

pezzi per scatola - pcs per box: **12**

peso lordo - gross weight: **8.30 Kg**

IMBALLO - PACKING

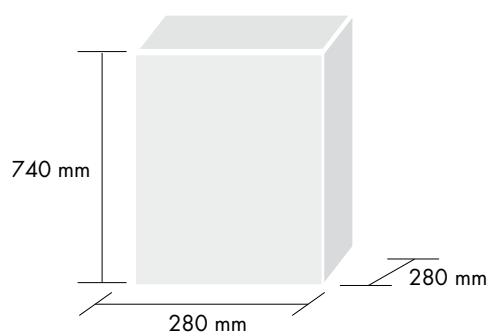

CODICE ARTICOLO - ARTICLE CODE

L3516

DESCRIZIONE - DESCRIPTION

Cestino in rete metallica traforata

Metal mesh waste bin

COLORI - COLOURS

nero - black

argento - silver

DETTAGLI TECNICI - TECHNICAL DATA

pezzi per scatola - pcs per box: **12**

peso lordo - gross weight: **8 Kg**

IMBALLO - PACKING

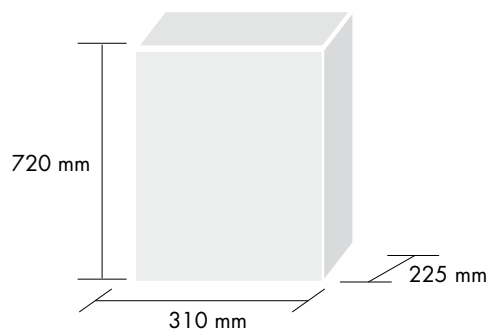



CODICE ARTICOLO - ARTICLE CODE

L5001

DESCRIZIONE - DESCRIPTION

Cestino in rete metallica traforata

Metal mesh waste bin

COLORI - COLOURS

argento - silver

nero - black

DETTAGLI TECNICI - TECHNICAL DATA

pezzi per scatola - pcs per box: **12**

peso lordo - gross weight: **8.20 Kg**

IMBALLO - PACKING

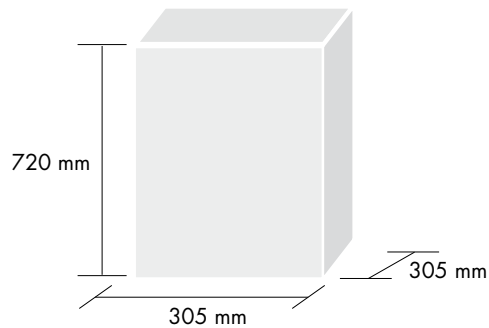

CODICE ARTICOLO - ARTICLE CODE

L5002

DESCRIZIONE - DESCRIPTION

Cestino in rete metallica traforata

Metal mesh waste bin

COLORI - COLOURS

argento - silver

nero - black

DETTAGLI TECNICI - TECHNICAL DATA

pezzi per scatola - pcs per box: **12**

peso lordo - gross weight: **6.40 Kg**

IMBALLO - PACKING

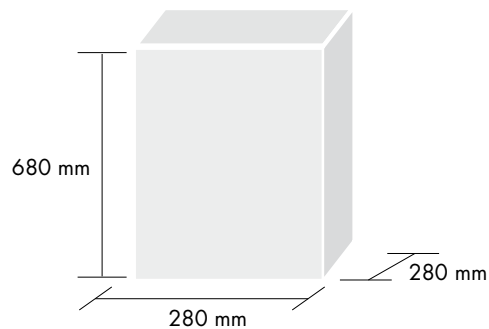



CODICE ARTICOLO - ARTICLE CODE

L6003 - L6004 - L6005

DESCRIZIONE - DESCRIPTION

Cestino in metallo senza fori, parzialmente forato o con fori

Metal waste bin without holes, with partial holes or with holes

COLORI - COLOURS

bianco - white

nero - black

argento - silver



DETTAGLI TECNICI - TECHNICAL DATA

pezzi per scatola - pcs per box: **06**

peso lordo - gross weight: **4 Kg**

IMBALLO - PACKING

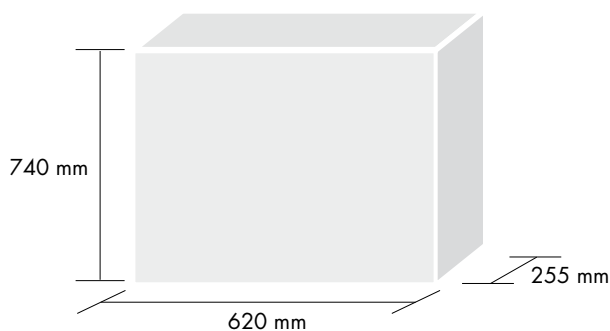

CODICE ARTICOLO - ARTICLE CODE

L8000 5LT

DESCRIZIONE - DESCRIPTION

Cestino in acciaio inox con pedale

Stainless steel pedal bin

DETTAGLI TECNICI - TECHNICAL DATA

pezzi per scatola - pcs per box: **06**

peso lordo - gross weight: **7 Kg**

IMBALLO - PACKING

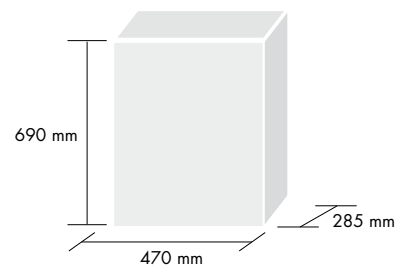

CODICE ARTICOLO - ARTICLE CODE

L8000 12LT

DESCRIZIONE - DESCRIPTION

Cestino in acciaio inox con pedale

Stainless steel pedal bin

DETTAGLI TECNICI - TECHNICAL DATA

pezzi per scatola - pcs per box: **04**

peso lordo - gross weight: **8.20 Kg**

IMBALLO - PACKING

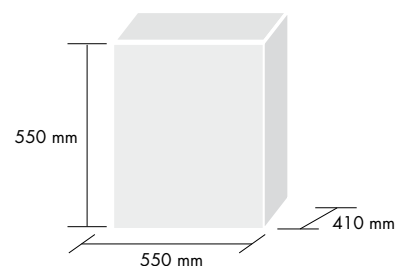



CODICE ARTICOLO - ARTICLE CODE

J3631

DESCRIZIONE - DESCRIPTION

Portaombrelli in rete metallica traforata

Metal mesh umbrella holder

COLORI - COLOURS

argento - *silver*

nero - *black*

DETTAGLI TECNICI - TECHNICAL DATA

pezzi per scatola - *pcs per box*: **06**

peso lordo - *gross weight*: **5.20 Kg**

IMBALLO - PACKING

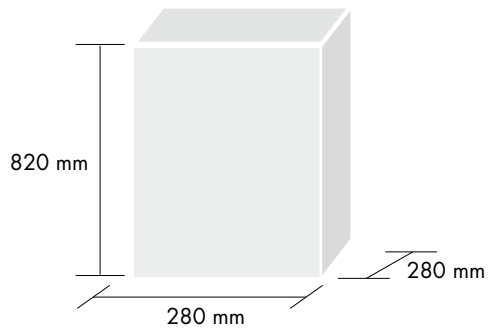



CODICE ARTICOLO - ARTICLE CODE

KIT 3514

DESCRIZIONE - DESCRIPTION

Kit scrivania ufficio

Office desk kit

COLORI - COLOURS

argento - silver

nero - black

DETTAGLI TECNICI - TECHNICAL DATA

pezzi per scatola - pcs per box: **06**

peso lordo - gross weight: **7.50 Kg**

IMBALLO - PACKING

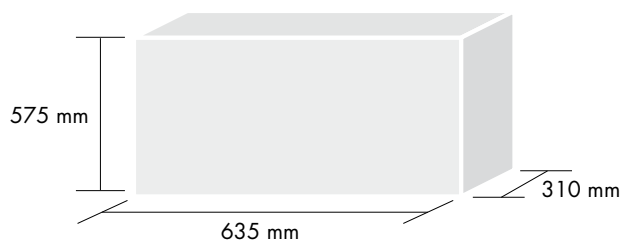

CODICE ARTICOLO - ARTICLE CODE

KIT 3577

DESCRIZIONE - DESCRIPTION

Kit scrivania ufficio

Office desk kit

COLORI - COLOURS

argento - silver

nero - black

DETTAGLI TECNICI - TECHNICAL DATA

pezzi per scatola - pcs per box: **06**

peso lordo - gross weight: **11 Kg**

IMBALLO - PACKING

